

5105 Elbow 90° long SDR11

Product information

Material

- PE100

Manufacture

- Injection moulded

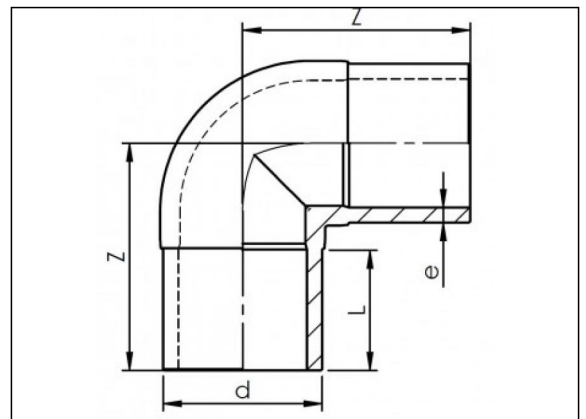

Available items

ART.CODE	d	L	Z	e	Verp
5105102000	20	46	66	2	100
5105102500	25	46	67	2.3	200
5105103200	32	49	77	3	100
5105104000	40	55	87	3.7	75
5105105000	50	60	99	4.6	70
5105106300	63	65	111	5.8	25
5105107500	75	72	126	6.8	30
5105109000	90	82	144	8.2	16
5105111000	110	86	162	10	10

Van de Lande BV

Lissenveld 1 \ 4941 VK Raamsdonksveer \ The Netherlands \ t +31 (0)162 51 60 00 \ f +31 (0)162 52 14 17 \ sales@vandelande.com
Traderegister Tilburg: 18070844 \ IBAN: NL13 RABO 0143 0035 26 \ BIC: RABONL2U \ VAT: NL 8123.91.755.B01

ART.CODE	d	L	Z	e	Verp
5105112500	125	90	177	11.4	4
5105114000	140	95	192	12.7	3
5105116000	160	103	212	14.6	2
5105118000	180	109	233	16.4	2
5105120000	200	116	254	18.2	1
5105122500	225	124	275	20.5	1

Van de Lande BV

Lissenveld 1 \ 4941 VK Raamsdonksveer \ The Netherlands \ t +31 (0)162 51 60 00 \ f +31 (0)162 52 14 17 \ sales@vandelande.com
Traderegister Tilburg: 18070844 \ IBAN: NL13 RABO 0143 0035 26 \ BIC: RABONL2U \ VAT: NL 8123.91.755.B01

All our transactions are subject to the Van de Lande General Terms of Sale. A copy of these can be provided immediately upon your request.