

# 5.24 Filling block

## Product information

**Material**

- PP = Polypropylene

**Manufacture**

- Injection moulded

## Parts



5.25 Tube clip

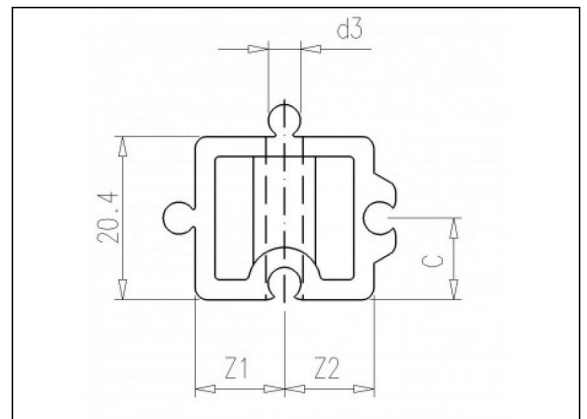

## Available items

ART.CODE	Maat	d3	Z1	Z2	H	C	E	Type	Verp
5.24.011	10/12	4.5	11	13.5	20	10	12	D	500 (50x10)
5.24.016	16	5.5	14	16.5	20	10	16	E	400 (40x10)
5.24.020	20	5.5	16.5	19	20	10	16	E	400 (40x10)
5.24.025	25	5.5	19	21.5	20	10	16	E	800 (80x10)

**Van de Lande BV**

Lissenveld 1 \ 4941 VK Raamsdonksveer \ The Netherlands \ t +31 (0)162 51 60 00 \ f +31 (0)162 52 14 17 \ sales@vandelande.com  
 Traderegister Tilburg: 18070844 \ IBAN: NL13 RABO 0143 0035 26 \ BIC: RABONL2U \ VAT: NL 8123.91.755.B01

ART.CODE	Maat	d3	Z1	Z2	H	C	E	Type	Verp
5.24.032	32	5.5	24	26.5	20	10	16	E	600 (60x10)
5.24.033	32	6.5	28.5	28.5	20	10	22	E	400 (40x10)
5.24.040	40	6.5	33.5	33.5	20	10	22	E	500 (50x10)
5.24.050	50	6.5	37	37	20	10	22	E	500 (50x10)
5.24.063	63	8.5	44.5	44.5	20	10	25	E	150 (15x10)
5.24.075	75	8.5	52	52	20	10	25	E	80 (8x10)
5.24.090	90	8.5	64.5	64.5	20	10	28	E	100 (10x10)
5.24.110	110	8.5	78	78	20	10	28	E	80 (8x10)
5.24.125	125	8.5	88	88	20	10	31.5	E	150 (15x10)
5.24.140	140	8.5	97	97	20	10	31.5	E	140 (14x10)
5.24.160	160	8.5	109	109	20	10	31.5	E	120 (12x10)

**Van de Lande BV**

Lissenveld 1 \ 4941 VK Raamsdonksveer \ The Netherlands \ t +31 (0)162 51 60 00 \ f +31 (0)162 52 14 17 \ sales@vandelande.com  
Traderegister Tilburg: 18070844 \ IBAN: NL13 RABO 0143 0035 26 \ BIC: RABONL2U \ VAT: NL 8123.91.755.B01

[www.vandelande.com](http://www.vandelande.com)

All our transactions are subject to the Van de Lande General Terms of Sale. A copy of these can be provided immediately upon your request.