

6.70 Vanne à papillon

Informations sur le produit

Caractéristiques

- INOX

Matière

- PVC-U = Polychlorure de vinyle rigide

Joints

- EPDM

Fabrication

- Moulé par injection

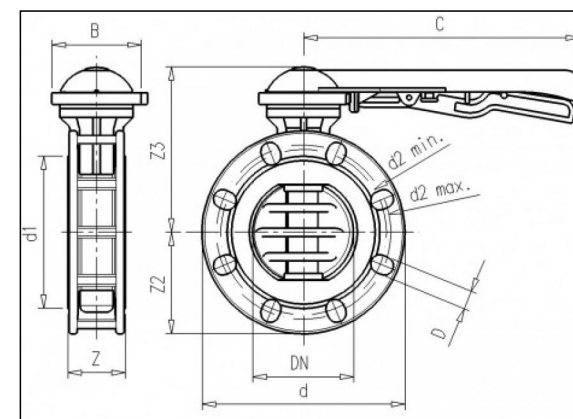

Pièces



6.76 Kit pour
vanne à
papillon

Van de Lande BV

Lissenveld 1 \ 4941 VK Raamsdonksveer \ The Netherlands \ t +31 (0)162 51 60 00 \ f +31 (0)162 52 14 17 \ sales@vandelande.com
Traderegister Tilburg: 18070844 \ IBAN: NL13 RABO 0143 0035 26 \ BIC: RABONL2U \ VAT: NL 8123.91.755.B01

All our transactions are subject to the Van de Lande General Terms of Sale. A copy of these can be provided immediately upon your request.

Articles disponibles

ART.CODE	Dia	DN	d	d1	d2	Z	Z2	Z3	B	C	NxD	PN	Verp
6.70.075	75	65	185	106	128/144	53	92.5	174	108	270	4x19	10	1
6.70.090	90	80	200	125	145/160	56	100	181	108	270	8x19	10	4
6.70.110	110	100	220	150	165/190	63	110	192	108	270	8x19	10	3
6.70.140	140	125	250	188	204/215	71	125	203	108	340	8x23	10	2
6.70.160	160	150	285	214	230/242	78	142.5	221	108	340	8x23	6	1
6.70.225	225	200	340	266	280/298	81	170	289	150	420	8x23	6	1

Van de Lande BV

Lissenveld 1 \ 4941 VK Raamsdonksveer \ The Netherlands \ t +31 (0)162 51 60 00 \ f +31 (0)162 52 14 17 \ sales@vandelande.com

Traderegister Tilburg: 18070844 \ IBAN: NL13 RABO 0143 0035 26 \ BIC: RABONL2U \ VAT: NL 8123.91.755.B01

All our transactions are subject to the Van de Lande General Terms of Sale. A copy of these can be provided immediately upon your request.