

6.80 Vanne à Guillotine

Informations sur le produit

Caractéristiques

- INOX

Matière

- PVC-U = Polychlorure de vinyle rigide

Joints

- EPDM

Fabrication

- Moulé par injection

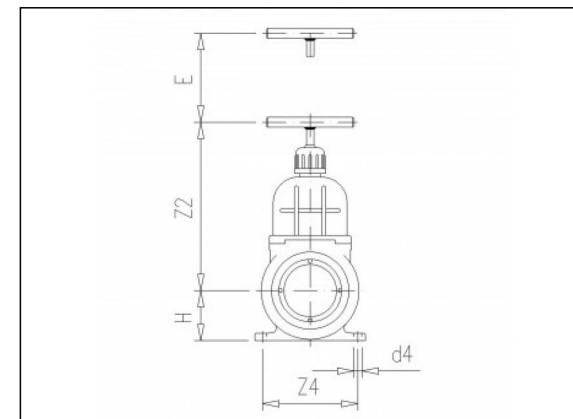

Pièces



6.45 Jeu de rechangé

Van de Lande BV

Lissenveld 1 \ 4941 VK Raamsdonksveer \ The Netherlands \ t +31 (0)162 51 60 00 \ f +31 (0)162 52 14 17 \ sales@vandelande.com

Traderegister Tilburg: 18070844 \ IBAN: NL13 RABO 0143 0035 26 \ BIC: RABONL2U \ VAT: NL 8123.91.755.B01

All our transactions are subject to the Van de Lande General Terms of Sale. A copy of these can be provided immediately upon your request.

Articles disponibles

ART.CODE	d1	d2	d4	Z1	Z2	Z4	B	C	E	H	P max	DN	Verp
6.80.050	50	42	7	29	139	76	31	91	52	40	3	40	25
6.80.063	63	54	9	38	164	98	38	114	65	51.5	2	50	12
6.80.075	75	64	9	39	187	112	44	127	73	57.5	1.5	65	8
6.80.090	90	76	9	45	218	138	51	148	91	71	1	80	6
6.80.110	110	92	9	55	250	158	61	177	108	81	1	100	4

Van de Lande BV

Lissenveld 1 \ 4941 VK Raamsdonksveer \ The Netherlands \ t +31 (0)162 51 60 00 \ f +31 (0)162 52 14 17 \ sales@vandelande.com

Traderegister Tilburg: 18070844 \ IBAN: NL13 RABO 0143 0035 26 \ BIC: RABONL2U \ VAT: NL 8123.91.755.B01

All our transactions are subject to the Van de Lande General Terms of Sale. A copy of these can be provided immediately upon your request.