

2.01 T-stuk 90°

Productinformatie

Materiaal

- PVC-U = Polyvinylchloride zonder weekmaker

Vervaardiging

- Spuitgiet

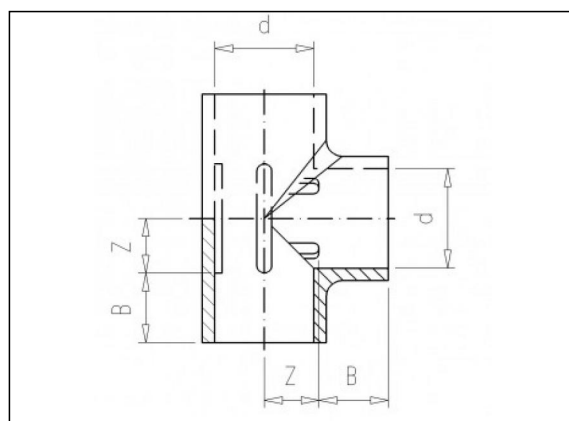

Beschikbare artikelen

ART.CODE	d	Z	B	PN	Verp
2.01.010	10	6	12	16	250 (5 x 50)
2.01.012*	12	7	12	16	250 (5 x 50)
2.01.016*	16	9.5	14	16	200 (4 x 50)
2.01.020*	20	11.5	16	16	100 (2 x 50)

Van de Lande BV

Lissenveld 1 \ 4941 VK Raamsdonksveer \ The Netherlands \ t +31 (0)162 51 60 00 \ f +31 (0)162 52 14 17 \ sales@vandelande.com
Traderegister Tilburg: 18070844 \ IBAN: NL13 RABO 0143 0035 26 \ BIC: RABONL2U \ VAT: NL 8123.91.755.B01

ART.CODE	d	Z	B	PN	Verp
2.01.025*	25	14.5	19	16	250
2.01.032*	32	17.5	22	16	225
2.01.033	32	17	22	10	250
2.01.040*	40	23.5	26	16	125
2.01.041	40	23	26	10	125
2.01.050*	50	27	32	16	75
2.01.051	50	27	32	10	75
2.01.063*	63	35	38	16	38
2.01.064	63	34	38	10	38
2.01.075	75	40	44	16	24
2.01.076	75	40	44	10	24
2.01.090	90	48.5	51	16	14
2.01.091	90	48.5	51	10	14
2.01.110	110	59	61	16	7
2.01.111	110	59	61	10	7
2.01.125	125	66	69	16	4
2.01.140	140	73.5	76	16	3
2.01.160	160	83	86	16	2
2.01.200	200	106.5	107	10	1
2.01.225	225	118.5	120	10	1
2.01.250	250	131	132	10	1
2.01.280	280	152	146	10	1
2.01.315	315	168	164	10	1
2.01.400	400	214	206	6	1

Van de Lande BV

Lissenveld 1 \ 4941 VK Raamsdonksveer \ The Netherlands \ t +31 (0)162 51 60 00 \ f +31 (0)162 52 14 17 \ sales@vandelande.com
Traderegister Tilburg: 18070844 \ IBAN: NL13 RABO 0143 0035 26 \ BIC: RABONL2U \ VAT: NL 8123.91.755.B01

www.vandelande.com

All our transactions are subject to the Van de Lande General Terms of Sale. A copy of these can be provided immediately upon your request.