

6.80 MES Schuifafsluiter

Productinformatie

Eigenschappen

- Roestvrijstaal

Materiaal

- PVC-U = Polyvinylchloride zonder weekmaker

Afdichting

- EPDM

Vervaardiging

- Smitgiet

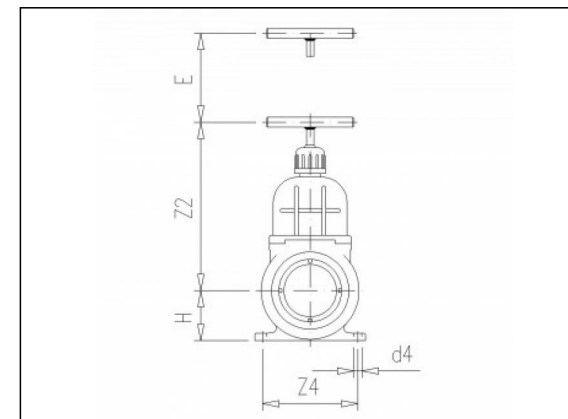

Van de Lande BV

Lissenveld 1 \ 4941 VK Raamsdonksveer \ The Netherlands \ t +31 (0)162 51 60 00 \ f +31 (0)162 52 14 17 \ sales@vandelande.com

Traderegister Tilburg: 18070844 \ IBAN: NL13 RABO 0143 0035 26 \ BIC: RABONL2U \ VAT: NL 8123.91.755.B01

All our transactions are subject to the Van de Lande General Terms of Sale. A copy of these can be provided immediately upon your request.

Beschikbare artikelen

ART.CODE	d1	d2	d4	Z1	Z2	Z4	B	E	H	P max	DN	Verp
6.80.111	110	92	9	54	290	158	61	107	81	0.5	100	4
6.80.161	160	150	11	55	388	240	86	165	108	0.5	150	2
6.80.201	200	192	13	48	450	275	107	200	128	0.5	200	1

Van de Lande BV

Lissenveld 1 \ 4941 VK Raamsdonksveer \ The Netherlands \ t +31 (0)162 51 60 00 \ f +31 (0)162 52 14 17 \ sales@vandelande.com
Traderegister Tilburg: 18070844 \ IBAN: NL13 RABO 0143 0035 26 \ BIC: RABONL2U \ VAT: NL 8123.91.755.B01

All our transactions are subject to the Van de Lande General Terms of Sale. A copy of these can be provided immediately upon your request.